

With Heart & Soil High performance agricultural tires



Download the app now:
Agriculture TireTech





Bringing home the harvest together. With tires you can trust.

Farming with Heart & Soil

Soil is the stage on which the great circle of life plays out. Changing with the weather and the seasons, it provides nurture and nourishment in a virtuous circle that repeats itself year upon year, round and round again.

No one understands this better than farmers. Without their passion no field would be plowed, no seed sown, no harvest brought home. Come rain or shine, snowy winter or clement spring, farmers can be relied on to get the best out of the soil. It's their co-partner and counterpart, productive and demanding, always the driving force in cultivating and bringing home the best possible harvest.

At Continental we're cut from the same cloth. Like farmers, we work with nature, overcome its adversities, and treat it with respect. Our partnership with farmers begins with our shared passion for soil and is based on twofold contact: on the one hand, our close contact with farmers, which helps us to understand their challenges and offer solutions to master them; on the other hand, the contact our tires have with the road and the field to bring farmers to where they want to go efficiently, comfortably and reliably.

We see partnership as a combination of the highest possible product quality and individual advice. We partner with farmers because we understand how they work and offer them precisely the right tires to suit each specific application - now with the bonus of VF technology. Within this partnership we help farmers to optimize their profits in keeping with our quality motto: Engineered for Efficiency. Just as farmers are at one with nature, we are at one with them as we cater to their every need - with heart & soil.

Lousado - a fertile soil that helps innovation grow

Developing innovations is what drives us. We plow a great deal of investment into this goal at our dedicated site: our production plant in Lousado, Portugal. Here, we have the ideal soil for growing innovations. This is where ideas blossom into the new technologies that constantly improve our farmers' day-to-day work.



Extended warranty for up to 10 years on all qualifying Continental agricultural tires

We guarantee our tires' performance over and above statutory requirements at no extra cost. In the unlikely event something goes wrong, we're by your side:

- **Basic coverage:** Manufacturing or material defects, up to 10 years after purchase
- **Stubble damage coverage:** Stubble damage, up to three years after purchase
- **Field hazard coverage:** Unintentional and unavoidable damage, e.g. puncture by debris, up to two years after purchase



If you need to make a claim, we'll subsidize the purchase of a new identical Continental tire. Our contribution to the cost of a new tire is limited to either the percentage of usable tread remaining, or percentage of remaining full years in the warranty period of the category you are claiming under, whichever is lower. Terms and conditions apply.

If you require detailed information about the extended warranty or have any other questions, don't hesitate to contact your sales representative.

Whatever the vehicle, whatever the task - we have the right tire.

Farmers use their tractors and other agricultural machinery for a wide range of demanding tasks. Developed using innovative technologies, every Continental tire is designed both to work in harmony with agricultural vehicles and help farmers with each of their specific jobs.



VF TractorMaster Hybrid



VF TractorMaster



TractorMaster



Tractor70



Tractor85



Tractor

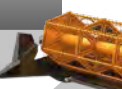

Harvester



VF CombineMaster



CombineMaster



CompactMaster AG CompactMaster EM MPT81



70E



Special Telehandler/Unimog/Backhoe Loader

Technology that's ahead of the field.

VF technology

Agricultural tires have to be all-rounders that deliver top performance on various soils and when carrying differing loads at varying speeds. Our VF technology (very high flexion technology) enables tires to do precisely that – and be gentle on the soil thanks to their broader footprint.

All this is possible thanks to an optimized size ratio between apex and bead that improves the tire deflection and reduces the compression on the outer surface of the rubber. The broader belt and shoulder area also optimize the distribution of forces to make the tires highly durable. The benefits are

huge: VF tires provide enhanced efficiency when switching between road and field, and can carry approx. 40% higher load than standard tires at the same tire pressure, or the same load at around 40% lower tire pressure.

VF technology tires

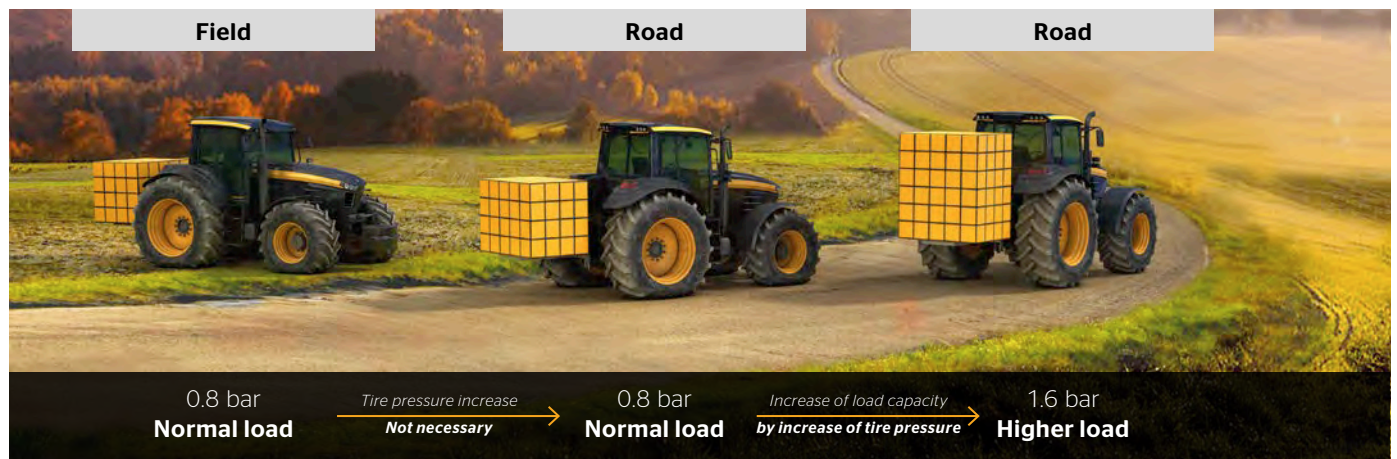

Standard tires





Significant VF details for stronger results all around.

- 1 Belt geometry**
 The broader and stronger belt and more robust shoulder area enhance the sturdiness and durability of a VF tire.
- 2 Bead geometry**
 The optimized bead geometry improves the bead area and sidewall deflection.
- 3 N.flex technology**
 The N.flex technology's nylon material gives the bead area and sidewall their flexibility.

d.fine
TECHNOLOGY

The lugs - specifically developed to stand their ground

Our new lugs refuse to give way: they firmly grip the ground beneath the tire to keep driving the tractor forward without slipping. A large surface area and additional special touches make the high performance and extremely robust tires adaptable to each specific location.

- 1 Deep lug overlap**
 - Benefits on the road: Comfortable drive, less vibration
- 2 5% more lug surface compared to standard tires**
 - Benefits in the field: High traction
 - Benefits on the road: Better mileage
- 3 Smooth linkage between block and base**
 - Benefits:
 - Stress resistant, damage resistant
 - Optimum self-cleaning
 - Traction
- 4 Sturdy blocks**
 - Benefits in the field: Stability



A strong pair of shoulders.

N.flex
TECHNOLOGY



Unique N.flex carcass technology

The carcass' patented material is flexible enough to absorb impact and then return to its original shape without permanent deformation. This ensures long-term robustness and rounder tires for a comfortable ride. A vast reduction in flat spots means an end to bumpy drives in the morning.

- High impact resistance due to high elongation of nylon
- High robustness: carcass structure absorbs impact energy without breaking

N.flex technology - for tires that never tire

Smooth roads, rocky lanes, muddy fields - with our new N.flex nylon technology, our tires can take one hell of a beating. At our high-tech plant in Lousado, we've developed a new type of nylon carcass that makes our tires more robust and round. Faced with rocky lanes and fields, they roll with the punches and absorb the impact by spreading it over a large area. But just like a farmer, nothing and no-one will bend them: they take their knocks and then quickly bounce back to their usual round shape for a smooth, comfortable ride.

After a gruelling day in the heat, our tires are ready for long drives and hard work the next morning: they retain their uniform shape for a comfortable ride with virtually no flat spots.

BEAD

TECHNOLOGY

The bead is essential to a tire, because it's what keeps it on the rim. Made of a single piece of wire, our beads are sturdy, compact, and keep their shape.

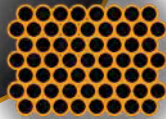
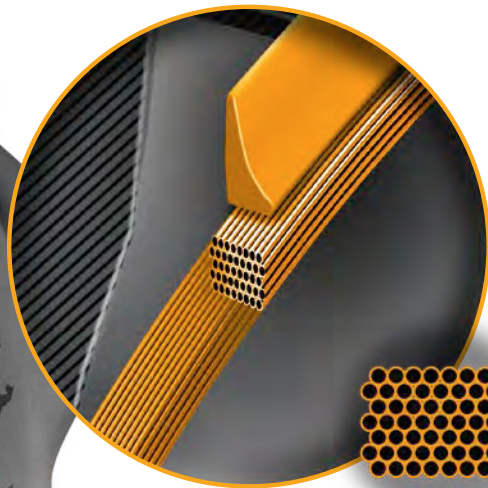

Rectangular bead core

The rectangular bead core design is optimized for the high torques of tractor tires, and for the rear axle tires on combine harvesters during all-wheel-drive.

- The optimized contours of the apex enable a high degree of sidewall deflection.

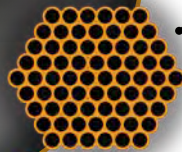
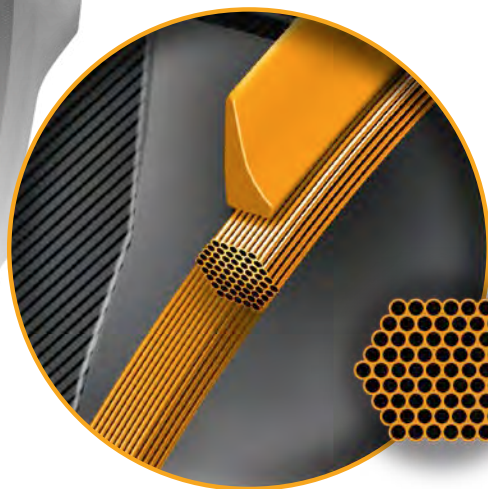

Hexa bead core

The hexa bead core has been especially designed for the front tires of combine harvesters.

- The carcass material wraps around the core better for better power transmission. Higher core strength and a compact construction.

The bead - where our world meets yours

Right from the word go, tractor tires are put through a test of strength and durability. Huge forces are applied to the bead when it is stretched over the rim, and it needs to snap right back into its original shape. This moment of truth is the next step in a partnership between our passion for engineering and the farmer's drive to harness the power of nature.

We leave nothing to chance during this crucial moment: each bead is made from a single piece of steel wire, and the hard-rubber rim strip covers the whole bead for easier mounting and enhanced durability. Our hexa bead technology is specially adapted for the front wheels of combine harvesters. With unmatched robustness and a constant shape, every Continental tire rolls as smoothly along the road as it did off the production line.

The technologies at the heart of our stable, robust tires.

Innovative technologies embrace every part of our tires, extending its life and making your investment go further. Whether on the road or in the field, they will enable you to work for longer in safety and comfort.

TURTLE SHIELD TECHNOLOGY

Turtle Shield - deflects sharp objects, protects the carcass

Inspired by nature, the Turtle Shield base tread line mimics the shape of a turtle's shell, making the shoulder area extremely robust by deflecting foreign objects before they can do any damage. The unique shape offers additional protection by ensuring that the rubber over the carcass is reinforced and tough.

Turtle Shield

- Increases robustness of tires
- Thick rubber and wide tread deflect objects from shoulder area
- Inspired by nature: turtle-shell shape deflects debris

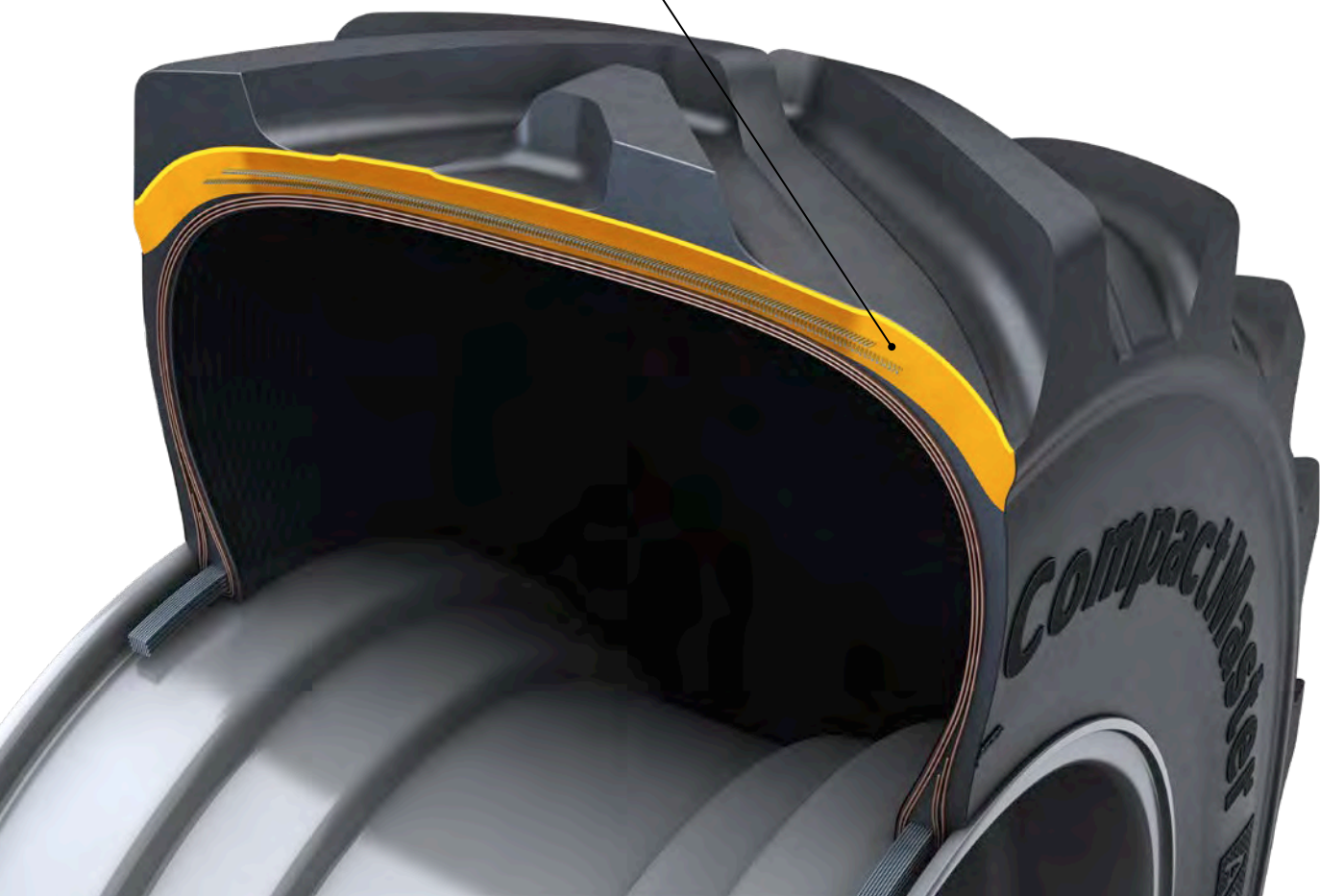

STEEL BELT

TECHNOLOGY

Twisted Steel Cords - tough and tensile

Two belt layers made of twisted steel cords provide high lateral stiffness for excellent tilting stability and exceptional protection of the central area of the tire - ideal for applications that involve reaching, picking and moving heavy loads. The open cord structure ensures that the entire surface of the steel is covered in rubber to protect against corrosion.

Steel Belt

- Protects central area against penetration and cuts from debris
- Crossed-steel layers, specifically designed for each tire size
- High tensile cords with a unique twist can withstand greater elongation, for increased robustness

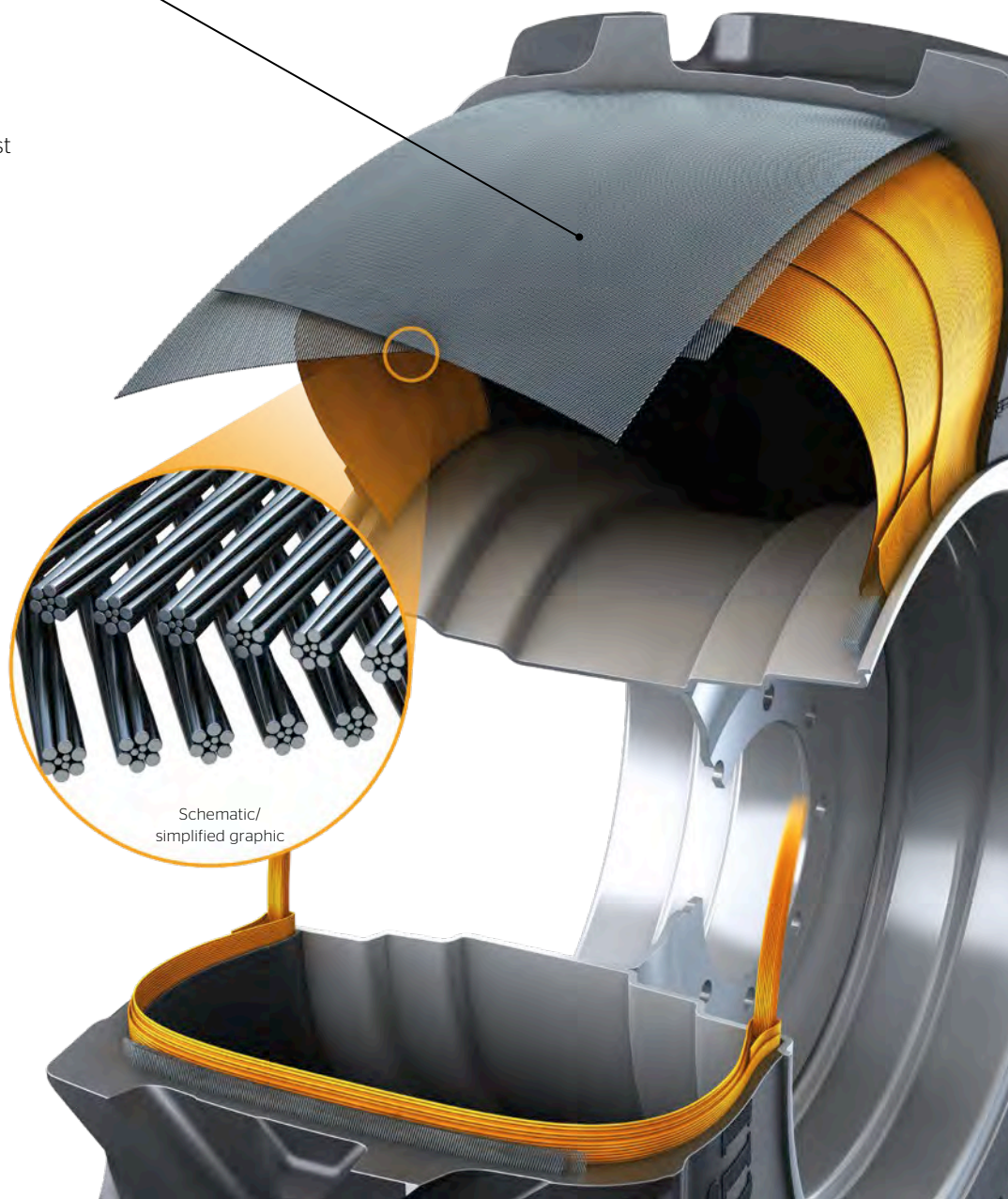

Continental 





Tractor Tires.

“The right tire depends on the job –
but the brand is always Continental.”



sensor
CONNECT

VF TractorMaster Hybrid comes pre-equipped with tire sensor. All other tires can be retrofitted.

VF TractorMaster Hybrid

Gentle on the farmer's soil and your bottom line.

Agricultural contractors can be on the road almost as much as they work the fields. But because tires respond differently to tarmacked surfaces than to grassland and fields, it's crucial to adapt. You can't change tires whenever you arrive at a farm, but you can choose our hybrid tire, the VF TractorMaster Hybrid. The innovative tread design squeezes out the maximum mileage on the highway, while delivering high traction and fuel efficiency in the field. You can move from field to road and back without making adjustments, as the VF TractorMaster Hybrid takes 40% higher loads at the same tire pressure. The built-in, contactless sensors will help you maintain the correct pressure - and with our web portal, you can do it whenever and wherever you want.



APPROVED BY
DLG
www.dlg.org

CONTINENTAL
VF TRACTORMASTER HYBRID
✓ Tyre efficiency
✓ Fuel savings in field work
✓ Transport work
DLG Test Report 7227

Feature	Effect	Benefit
1 Tread with large surface	• 30% larger surface	• High mileage on road • Good traction on hard and normal soil
2 Central block band	• Good surface adaptability	• Reduced noise and vibration
3 Rounded lugs	• Reduced cutting of roots on grassland • Minimized slippage on sandy soil	• Grassland protection • Lower fuel consumption
4 Bead technology	• High sidewall deflection performance	• Low soil compaction

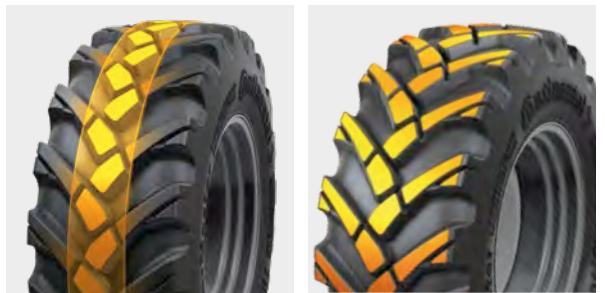



VF TractorMaster

Less pressure on fields.

Road to field, field to road, again and again: day after day, different soil conditions, loads and speeds demand decisions of a farmer. With the VF TractorMaster, our engineers have developed a tire that facilitates such decisions. Our VF technology allows these tires to be driven with approx. 40% higher load or approx. 40% lower tire pressure, which is ideal for flexibility switching between road and field - and reducing soil compaction while improving traction in the field.



Feature	Effect	Benefit
1 VF technology	<ul style="list-style-type: none"> Approx. 40% higher load or approx. 40% lower tire pressure 	Efficient switching between road to field: <ul style="list-style-type: none"> Higher productivity on roads Improved traction on fields
2 d.fine lug technology	<ul style="list-style-type: none"> 5% larger lug surface than standard tires 	<ul style="list-style-type: none"> Optimum traction
3 N.flex technology	<ul style="list-style-type: none"> Great impact resistance due to maximum elongation of nylon 	<ul style="list-style-type: none"> Excellent robustness
4 Bead technology	<ul style="list-style-type: none"> High sidewall deflection performance 	<ul style="list-style-type: none"> Low soil compaction

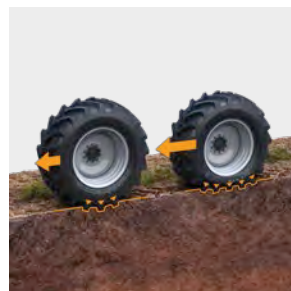



TractorMaster

Higher durability and mileage.

Driven by passion and dedication, the farmer works in the field for as long as it takes to bring in the harvest. Likewise, our engineers go that extra mile so our tires can support the farmer in all weather and on all terrain. They are miles ahead of standard tires, integrating N.flex technology, the innovative bead design and advanced d.fine lug technology. Longer-lasting tires take dedicated farmers further.



Feature	Effect	Benefit
1 d.fine lug technology	• 5% larger lug surface than standard tires	• Optimum traction
2 N.flex technology	• Great impact resistance due to maximum elongation of nylon	• Excellent robustness
3 Bead technology	• High sidewall deflection performance	• Low soil compaction

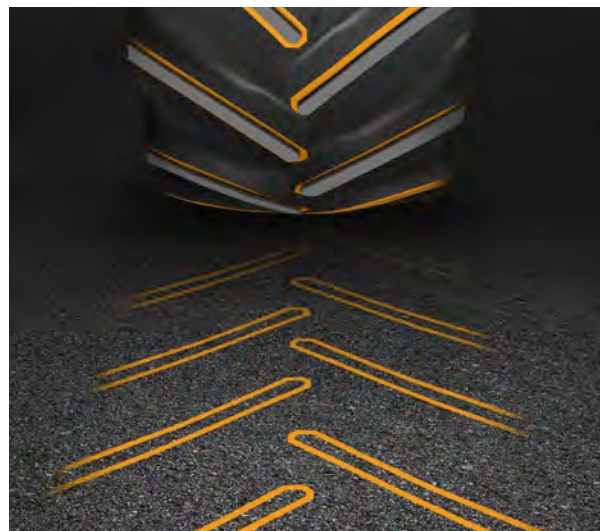



Results that leave an impression.

The DLG (German Agricultural Society) is a non-profit, politically independent organization that strives for technical and scientific progress in crop production, farm machinery and animal husbandry. It puts farm machinery and tires through their paces to help farmers invest wisely. These two Continental tires were tested by DLG and received the DLG test certificates.

VF TractorMaster Hybrid



CONTINENTAL VF TRACTORMASTER HYBRID

- ✓ Tyre efficiency
- ✓ Fuel savings in field work
- ✓ Transport work

DLG Test Report 7227



▶ Tire efficiency in the field

On same level as reference hybrid tire and 0,4% better than standard tire

▶ Fuel savings in the field

With 1,8% best result of tested tires

▶ Uphill fuel savings

With 2,0% best result of tested tire



Scan to see the full test.

TractorMaster



CONTINENTAL TRACTORMASTER

- ✓ Fuel consumption
- ✓ Area treated per hour
- ✓ Tyre efficiency
- ✓ DLG PowerMix transport cycles

DLG Test Report 7041



▶ Fuel consumption

between 2.5% and 5% lower than reference tires

▶ Ground coverage (ha/h)

▶ Tire efficiency

over 67% higher than the others due to width



Scan to see the full test.



Tractor70

Maximum traction,
minimum soil compaction.

Farmers are not only tough, they are also conscientious in the way they treat the environment. In fields they need robust tires that tread lightly and treat the precious soil with care. Tractor70 tires are wider than standard ones and therefore have a larger footprint. In combination with optimum self-cleaning properties and smooth, rounded lugs, Tractor70 tires deliver impressively high traction. What's more, the special bead design enables these tires to be driven at lower pressures than conventional tires, which is gentler on the soil.



Feature	Effect	Benefit
1 Bead technology	<ul style="list-style-type: none"> Longer footprint due to 0.2 bar lower pressure 	<ul style="list-style-type: none"> Low soil compaction Good traction
2 Tread design	<ul style="list-style-type: none"> Smooth interlug design and center line 	<ul style="list-style-type: none"> Good self-cleaning properties
3 N.flex technology	<ul style="list-style-type: none"> Flexibility due to low shrinkage of nylon material 	<ul style="list-style-type: none"> Comfort (better damping*)

* Compared to conventional tires



Tractor85

The all-rounder
that fits every job.

The Tractor85 is a tire for all seasons and all surfaces. It is a true all-rounder: narrow enough to fit neatly into a furrow, but wide enough to fill the role of a versatile, heavy-duty farm tire. Thanks to its special N.flex technology, the Tractor85 is durable and robust. Its nylon carcass makes the tire extremely flexible, able to absorb more impacts than other tires and less susceptible to flat spots - for a comfortable ride over fields and tarmac alike.



Feature	Effect	Benefit
1 Bead technology	<ul style="list-style-type: none"> Longer footprint due to 0.2 bar lower pressure 	<ul style="list-style-type: none"> Low soil compaction Good traction
2 Tread design	<ul style="list-style-type: none"> Smooth interlug design and center line 	<ul style="list-style-type: none"> Good self-cleaning properties
3 N.flex technology	<ul style="list-style-type: none"> Flexibility due to low shrinkage of nylon material 	<ul style="list-style-type: none"> Comfort (better damping*)

* Compared to conventional tires







Combine Tires.

“Feel how loads go hand in hand.”

VF CombineMaster

The master of cyclical loading.

During harvesting operations, tires are not only subjected to high speeds on the road they also have to deal with cyclical loading on the field. While the counterweight of the cutting unit effectively lightens the load on the field, tires have to cope with greater weight and faster speeds on the road.

Our VF technology allows tires to be used at reduced tire pressure so they can be driven on roads and fields without adapting the tire pressure or impacting their durability. As a rule of thumb, VF technology tires can offer approx. 40% higher load or approx. 40% lower tire pressure than standard tires.



Feature	Effect	Benefit
1 VF technology for steering axles	<ul style="list-style-type: none"> Approx. 40% higher load or approx 40% lower tire pressure 	<ul style="list-style-type: none"> High load capacity on road
2 Rectangular bead	<ul style="list-style-type: none"> Power thanks to high torque from rim to tire 	<ul style="list-style-type: none"> Traction
3 N.flex technology	<ul style="list-style-type: none"> Flexibility due to low shrinkage of nylon material 	<ul style="list-style-type: none"> Low vibrations High comfort
4 d.fine lug technology	<ul style="list-style-type: none"> Smooth linkage between block and base 	<ul style="list-style-type: none"> High wear resistance





CombineMaster

Hexa bead design – for high loads.

A combine harvester does the work of many hands. But one person is irreplaceable: the farmer. It is the farmer who has to safely steer these heavy machines along in the field. The broad shoulders, long footprint and optimized stability of our CombineMaster tires provide farmers with invaluable support. With every detail developed for reliability and in combination with N.flex and d.fine technology, these tires are the ideal solution when safety and soil protection are at stake.

The ideal solution for every combine harvester axle:

- ➊ **Front axle:** CombineMaster with hexa bead design
- ➋ **Rear axle:** VF CombineMaster with rectangular bead design

Feature	Effect	Benefit
➊ N.flex technology	➊ Flexibility due to low shrinkage of nylon material	➊ Low vibration ➋ High comfort
➋ d.fine lug technology	➊ Smooth linkage between block and base	➊ High wear resistance
➌ Hexa bead design	➊ Compact bead for high load	➊ Maximum carcass load capacity







Special Tires.

“Continental tires support me through all life’s twists and turns.”

NEW

CompactMaster AG

Excellent traction while moving heavy loads, anywhere on the farm.

Work on farms often entails reaching out to move heavy loads while pivoting, then transporting them. But loading, collecting and moving heavy items places even greater demands on vehicles when working in fields, on grassed land and on paved areas. This is why the versatile CompactMaster AG is designed to withstand strain in all directions, on all surfaces.

With the aid of the Steel Belt Technology, the CompactMaster AG retains its shape and stiffness to prevent tilting. The Turtle Shield technology provides excellent robustness. The CompactMaster AG enables speeds of up to 50 km/h on the road, even when towing trailers.



Feature	Effect	Benefit
1 Turtle Shield	<ul style="list-style-type: none"> Protects the shoulder area against penetration and cuts from foreign objects (high volume of rubber in shoulder area) 	<ul style="list-style-type: none"> Robustness
2 Steel cords with a unique twist	<ul style="list-style-type: none"> For high tire stiffness in lateral direction Protection against foreign objects in central area 	<ul style="list-style-type: none"> High tilting stability Robustness
3 Tread design with <ul style="list-style-type: none"> 5% wider lug base* Increased area between lugs 	<ul style="list-style-type: none"> Pattern stability Easy dislodging of adhesive soil 	<ul style="list-style-type: none"> High traction on various grounds Good self-cleaning behavior

* Compared to standard agricultural pattern



CompactMaster EM

Tread pattern with flexible blocks reduces wear on firm ground.

Our CompactMaster EM tire is ideal for vehicles that work on paved surfaces, asphalt, sand and gravel, both in agriculture and the construction industry. In these conditions, vehicles cover extensive mileage in unpredictable situations, including pivoting while reaching and carrying heavy loads.

The CompactMaster EM meets these challenges head-on by integrating the Turtle Shield and Steel Belt Technology to prevent punctures and maximize robustness across the areas of the tire that are subjected to the most strain. The special tread pattern contains a high volume of rubber, while the intricate surface of the flexible blocks reduces wear when turning on the spot.



Feature	Effect	Benefit
1 Turtle Shield	<ul style="list-style-type: none"> Protects the shoulder area against penetration and cuts from foreign objects (high volume of rubber in shoulder area) 	<ul style="list-style-type: none"> Robustness
2 Steel Cords with a unique twist	<ul style="list-style-type: none"> For high tire stiffness in lateral direction Protection against foreign objects in central area 	<ul style="list-style-type: none"> High tilting stability Robustness
3 Tread pattern with 50% positive ratio and flexible tread block	<ul style="list-style-type: none"> High rubber volume, flexible block movement when turning on the spot 	<ul style="list-style-type: none"> High mileage performance and low slippage





MPT81

Dedicated to service on all terrains and in multiple applications.

Whether you're repairing the Champs-Elysees, putting out forest fires, or digging gravel - the MPT81 ensures high performance, long life and versatility, on all surfaces and in all conditions. The design of the pattern's central band delivers speed and fuel efficiency, while the shoulder area ensures traction on loose surfaces. The tire pressure can be reduced to provide a better grip on soil, while the Rim Protection Rib prevents air leaks.



The ideal tire for your individual usage:

- 🔹 **Application:** Rescue services | Forestry | Construction sites | Municipal | Winter road service*
- 🔹 **Vehicles:** Municipal vehicles | Pickup trucks | Mobile homes | Off-road trucks | Wheel loaders | Telehandlers

* Approved for use where the Three Peak Mountain Snow Flake (3PMSF) certification is usually required by the German Ministry of Transport and Digital Infrastructure. Check the legal requirements for your country.

Feature	Effect	Benefit
1 Multifunctional tread design	• Three tread depth variations	• High performance on any surface
2 Turtle Shield Design	• Protects upper sidewall and shoulder area	• Robustness and puncture resistance
3 Special tread design with multiple block geometries	• Excellent self-cleaning capabilities	• High traction performance





70E

Dependable performance on challenging surfaces.

The Continental 70E can withstand demanding maneuvers and tight turns across a wide range of terrains. It offers high traction on gravel and soil thanks to the wider-spaced, deeper lugs at the tire's edge, while the tighter, shallower pattern in the central area is optimized for efficiency on flat concrete - whether reversing or driving forward. The Steel Belt, Turtle Shield and Rim Protection Rib technologies protect the tire from foreign objects to ensure excellent productivity and minimum downtime.



The ideal tire for your individual usage:

- 📍 **Application:** Construction sites | Forestry | Agriculture | All terrain
- 📍 **Vehicles:** Wheel loaders | Telehandlers

Feature	Effect	Benefit
1 Two-fold pattern design	• Dense block configuration with open outer tread design	• High work efficiency and low fuel consumption
2 Symmetrical pattern design	• High traction capability when driving forward or in reverse	• High work efficiency
3 Tight rim fit	• Bead protection for sidewall	• Reduces risk of flat tires

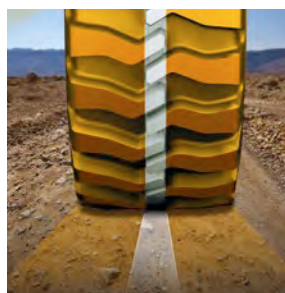





Digital Solutions.

“It’s easy to make every tire perform to its fullest potential.”

Harvest data to increase your yield

Correctly inflated tires live longer, reducing purchase and fitting costs while minimizing downtime. Continental's suite of digital solutions keeps farmers aware of the overall picture, notifying you when action is necessary to solve problems before they arise.

Each VF TractorMaster Hybrid tire comes with a built-in tire sensor, ready to connect to the ContiPressureCheck system. Any other Continental tire can be retrofitted with a sensor. Pressure and temperature are reported every two minutes.

Beyond increasing tire lifetime and performance, our digital solutions improve safety, productivity, eco-friendliness and more, and can be integrated into third-party data-driven management systems.

Your benefits



Data accuracy



Improved productivity



Cost efficiency



Versatility



Safety



Reliability



Eco-friendly



Transparency

ContiPressureCheck Single Vehicle Monitoring

ContiPressureCheck provides drivers with precise status information by continually monitoring air pressure and temperature via the tire sensor. The system displays data in the driver's cab and warns before a condition becomes critical. ContiPressureCheck is a complete, driver focused system for single vehicles and can be integrated into third party telematics solutions.



ContiPressureCheck single is the perfect single-vehicle solution for monitoring tire pressure and temperature using a dashboard display which provides the driver with a continuous view of tire data.

ContiPressureCheck integrated allows OEMs and telematics providers to offer end users an easy solution for monitoring tire pressure and temperature. In the integrated version, this display is already included in the vehicle telematic system of the customer or OEM. Data can be submitted via a third party telematic system to fleet managers.

Required kits per vehicle

	ContiPressureCheck Single	ContiPressureCheck Integrated						
Components	<ul style="list-style-type: none"> Display Hand-Held tool Receiver/Central Control Unit (CCU) Tire sensors 	<ul style="list-style-type: none"> Hand-Held tool Receiver/Central Control Unit (CCU) Tire sensors In vehicle telematics integration proprietary 						
Tractor	Required Kits	Required Kits						
	<table border="1"> <tr> <td>1.2</td> <td>4.2.4</td> </tr> <tr> <td>6.2</td> <td>HHT</td> </tr> </table>	1.2	4.2.4	6.2	HHT	<table border="1"> <tr> <td>1.2</td> <td>4.2.4</td> </tr> </table>	1.2	4.2.4
1.2	4.2.4							
6.2	HHT							
1.2	4.2.4							

● **Basic Kits** CCU, Brackets, Cables, CTU, YR
 ● **Sensor Kits** Sensor
 ● **Advanced Kits** Display, Cables
 ● **Accessories** Hand-Held tool

Connect your tires - Modular components

ContiPressureCheck Single Vehicles	
	<p>Hand-Held tool</p> <ul style="list-style-type: none"> Initial configuration of entire system Wireless communication with tire sensors Synchronizes tire sensors to each wheel position Wired communication with CCU
	
	<p>Display in the driver's cabin</p> <ul style="list-style-type: none"> Display shows the status of the tire and indicates 7 different types of warnings and the related tire position in the driver's cabin
	<p>Third party display in the driver's cabin</p> <ul style="list-style-type: none"> Display shows the status of the tire and indicates 7 different types of warnings and the related tire position
	
	<p>Tire sensor</p> <ul style="list-style-type: none"> Integrated battery-powered tire sensor with radio frequency transmitter - individual coding per running wheel Sends data every 2 minutes
	<p>Receiver/Central Control Unit (CCU)</p> <ul style="list-style-type: none"> Receives and evaluates signals from tire sensors Generates warnings and provides them for display - Up to 24 tires fitted on up to 6 axle
	
	<p>Cleaning Scraper & Mounting Tool (for retrofitment of sensor)</p> <ul style="list-style-type: none"> Scraper for pretreating the inner layer of the tire Pressing tool including insert Tool for pressing on the tire sensor during bonding
	<p>Additional Receiver</p> <p>Integrated antenna and receiver to be used if:</p> <ul style="list-style-type: none"> Vehicle has an axle spread of more than 6m Vehicle has more than 3 axles A trailer is docked

	Description	Article Number
● Basic Kits	Kit 1.2 Without additional receiver	17 34 115
	Kit 2.2 With additional receiver	17 34 116
● Sensor Kits	Tire sensor in Container	17 34 005
	Kit 4.2.4 4 Tire sensors	17 34 118
	Kit 4.2.6 6 Tire sensors	17 34 119
● Advanced Kits	Kit 6.2 Tire View (Display)	17 34 121
Tire sensor mounting & spare parts	Cleaning Scraper	17 34 130
	Mounting tool (Tire sensor)	17 34 019
	Insert - Mounting tool	17 34 022
	Set Tire Sensor Container 12	17 34 072
System configuration & spare parts	Set Hand-Held tool incl. accessory	17 34 052

Continental TireTech App

Make your daily work more efficient



The core element of the app is the Pressure-Load Calculator, which allows farmers to check the right pressure for their tires depending on the load.

The app enables you to determine the right pressure for your Continental agricultural tires based on their dedicated application in daily farming activities. This results in lower soil compaction, less wear on the tires, greater efficiency and lower fuel consumption. In addition to the Pressure-Load Calculator, the app offers a wide range of technical information on Continental's agricultural tire portfolio, as well as a useful conversion table.

App Features:

Pressure-Load Calculator

The application uses the load to calculate the best tire pressure for achieving optimum efficiency and maximum service life. The right pressure will also help you conserve your field and get the highest yield possible.

Lead Calculator

The Lead Calculator compares the rolling circumferences of all Continental tires and provides a recommendation on whether the tires you have selected are compatible with the mechanical transmission of your tractor.

Technical Information

Browse through products, technologies and sizes.

Contact Form

Contact our Sales team if you have any questions about our tires.

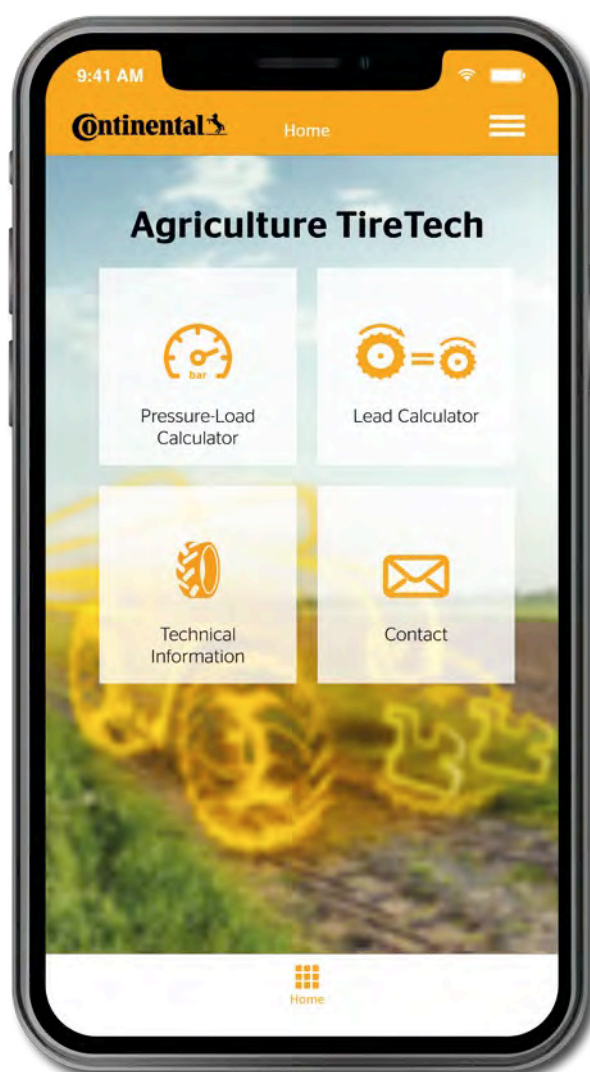

Download the app for free now:

Agriculture TireTech



Pioneering eco-friendly innovations.

Continental works on pioneering renewable resources such as Taraxagum. For this successful initiative, Continental has received the European environmental prize "GreenTec Award." The tire manufacturer also complies with the European Chemicals Directive REACH that stipulates the Registration, Evaluation, Authorization and Restriction of Chemicals.

Continental Commercial Specialty Tires (CST) continuously invests in the development of sustainable innovations for economically and ecologically efficient mobility. Besides the reduction of fuel and energy consumption, the tire manufacturer focuses on enhancing the tires' performance for an extended lifecycle. Long-lasting tires consume less energy across the entire manufacturing process and in application. In addition, Continental CST strives to utilize the most environmentally friendly raw material sources.

Continental CST will continue to work on enhancing the sustainable performance of its tires so as to make a valuable contribution to the protection of the environment and to a cleaner future.



Continental Reifen Deutschland GmbH

Commercial Specialty Tires

Büttnerstraße 25, 30165 Hannover, Germany

Phone: +49 511 938 - 01

www.continental-agriculture.com